



D'ANGLE SERIES

Assembly and operating manual

Models:

- D'Angle XL

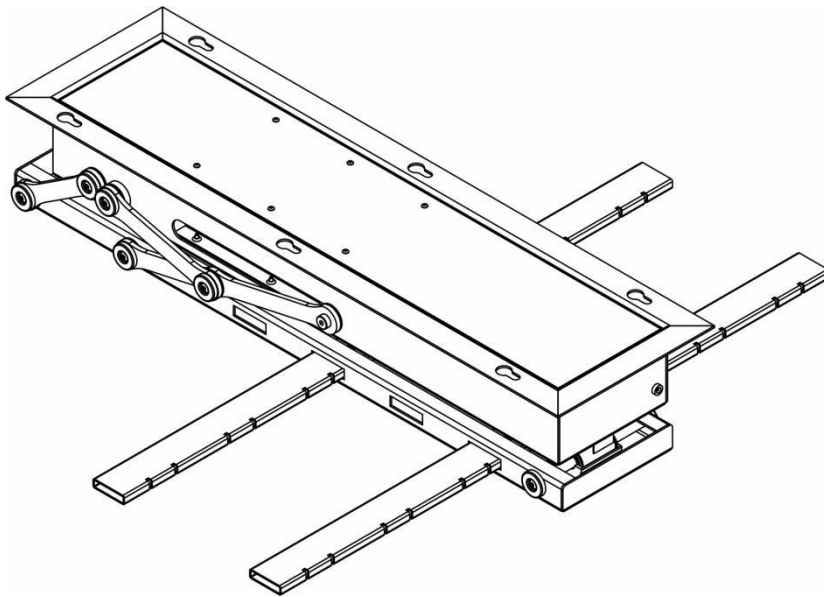





Pre-Installation Guidelines and Safety Precautions

Before installing this unit, always verify:

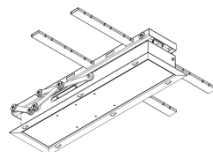
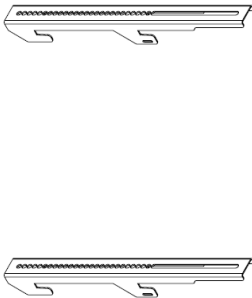

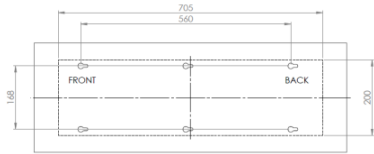



- Ensure that the contents are not damaged. Operating a damaged unit can be dangerous and may lead to further damage. Note that damages resulting from the operation of a compromised unit may not be covered under warranty..
 - Confirm that the structural integrity of your building is sufficient to support the weight of both the unit and the TV.
- Ensure that you have sufficient cable length to accommodate the full range of movement.
 - Verify that the TV is mounted correctly. If the TV's center of gravity is too far from the bracket's rotation axis, it may hinder the proper functioning of the bracket.

Kit contents



No.	Part name	Quantity	Fig.
1.	D'Angle Bracket	1 pc.	
	D'Angle horizontal beam	2 pc.	
2.	Sabaj IR Remote	1 pc.	
3.	IR-EYE receiver	1 pc.	
4.	Drilling Template	1 pc.	
5.	24V AC adapter	1 pc.	

6.	Mounting screw DIN 571 with an expansion plug	4 pcs.	
----	---	--------	---

Set contents

Tv Mounting Accesories TVMNTSET			
No.	Part name	Quantity	Fig.
1.	Screws ISO 4762	1 set.	M6 x 16 - 4 pcs. M6 x30 - 4 pcs. M5 - 15 - 4 pcs. 
2.	Screws ISO 7380	1 set.	M8 x 20 - 4 pcs. M8 x 30 - 4 pcs. 
3.	Pads ISO 7089, ISO 7093	1 set.	Size 6 - 4 pc. Size 8 - 4 pc. Size 8 large - 2 pc. 
4.	Allen keys	1 set.	size 3; 5 
5.	Plastic spacers (12,5mm)	4 pcs.	
6.	Plastic spacers (10mm)	4 pcs.	
7.	Velcro tapeA	2 pcs.	

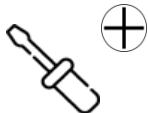
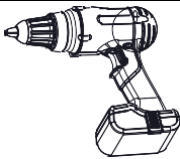
Required additional tools:

No.	Tool name	Fig.
1.	Cross screwdriver	
2.	Drill driver	
3.	Drill (suitable for screws)	

Assembly

1. Apply the template, drill holes in the ceiling and mount the screws (fig. 1).

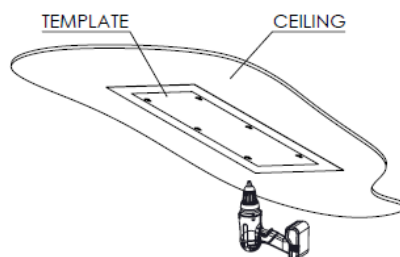

(fig. 1)

2. Assemble the D'angle bracket by inserting and screwing in the two horizontal brackets. There are multiple openings available for the brackets – choose the ones that best fit your TV, ensuring to position the TV's center of mass as close to the rotation axis as possible . If the distance is too big (fig 2) , the TV's weight might be too high for your Bracket. One also needs to consider the extension distance (30 mm) to ensure that the TV does not collide with the ceiling.

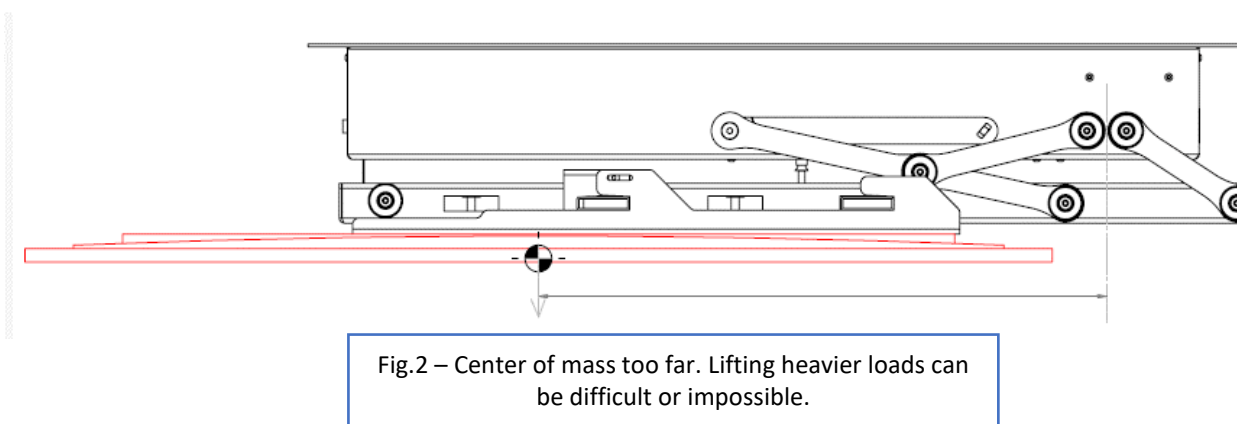
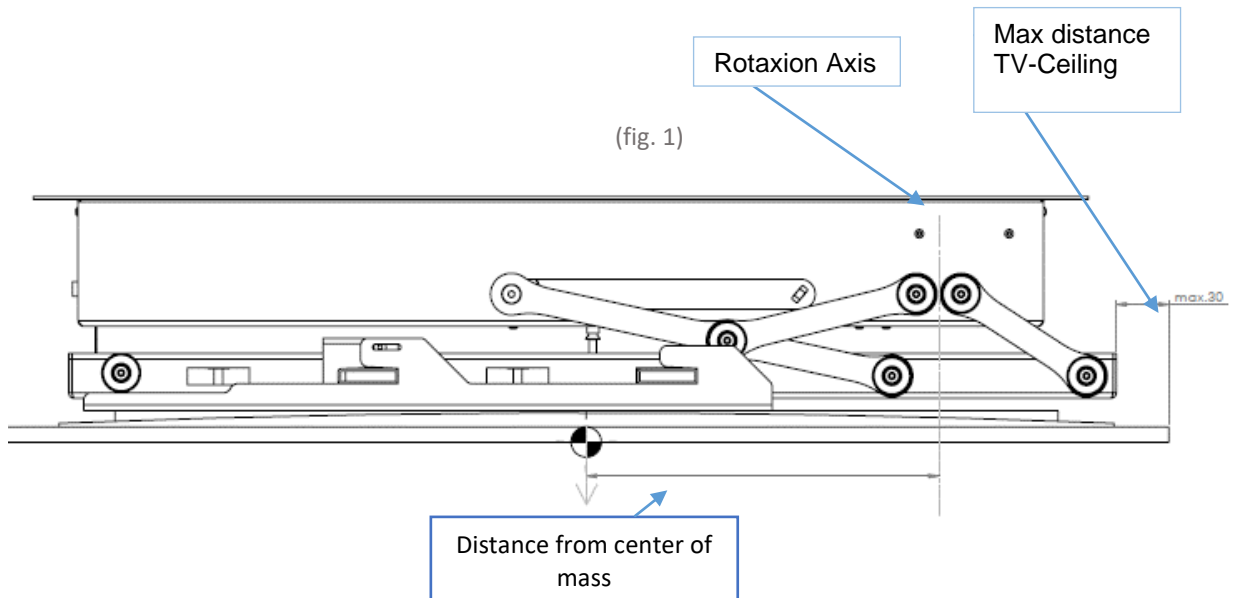

3. Hang D'Angle on the ceiling screws and tighten them.

NOTE: You will notice more than four holes for wall installation. Additional holes are added only for a sturdier installation or for necessary placement changes.

Attaching mounting brackets to the TV.

Mount the vertical beams to the TV using screws supplied by the TV manufacturer, or optionally one of the included in the set. If needed, use the supplied spacer elements to mount the TV (fig. 3).

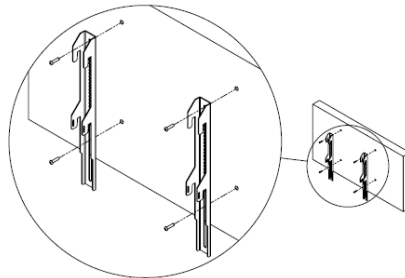

(fig. 3)

Hang the TV on the mount

Hang the TV using the beams installed on the mount. To facilitate installation, you can unfold the mount. Unfolding an underweight mount can result in belt wrapping. To avoid belt wrapping, apply some weight on the unit, to keep the belt tensioned. Secure the mount by locking the lower brackets onto the vertical beams as shown below.

It is crucial to firmly secure the beams to prevent the screen from falling.

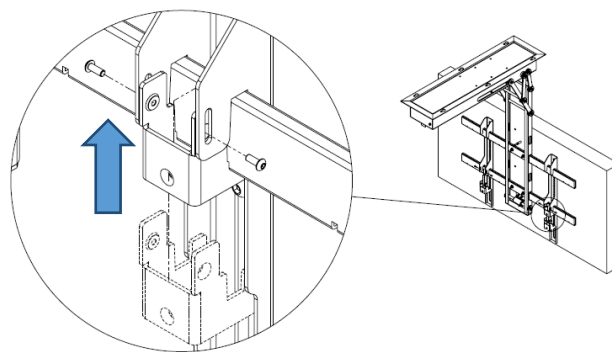

Connecting the mount

Connect the AC power adapter and IR receiver to corresponding sockets, like shown on pictures below.

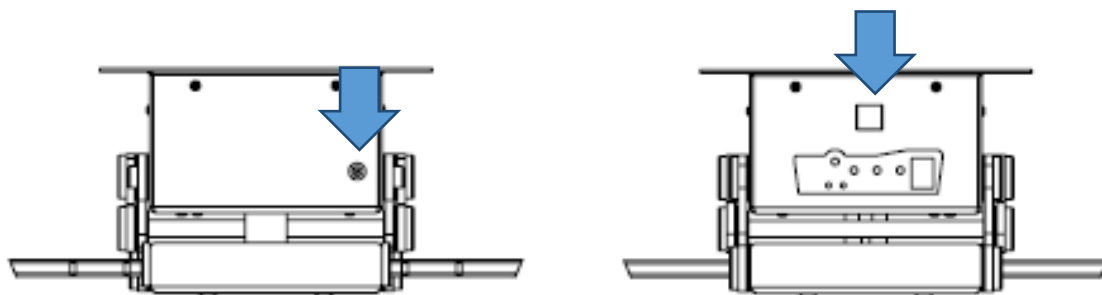

(fig. 5)

Place the IR receiver, so that it is visible to the remote control (fig. 6).

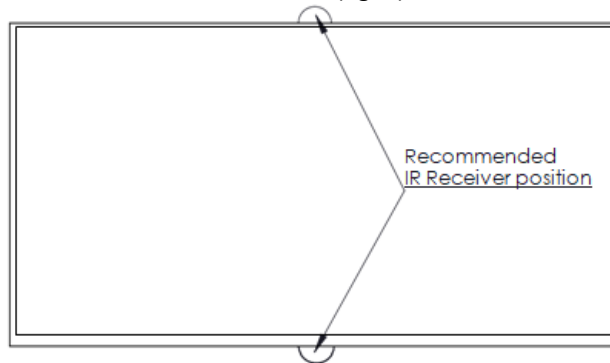

(fig. 6)

Control panel description

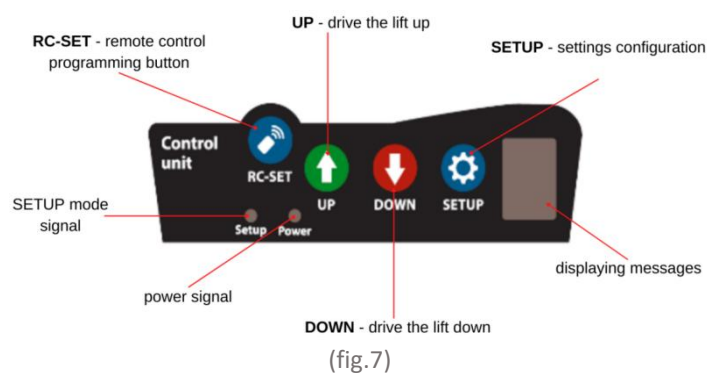

(fig.7)

Initial Setup and Operation of the Electric Bracket.

Your D'Angle bracket is pre-programmed for the maximum ranges of the unit movement.
To change the movement range:

Setting movement limit

Setting Movement Limits

Using the programmed remote control, you can set custom range of motion. To set the low limit:

Press & hold **SETUP button** for about 2 seconds – **red SETUP led** will be lit and you will hear 2 short „beep” signals. The controller is now in the programming mode

- a. Use **Up/Down buttons** to set your preferred Down position
- b. Press **RC-SET button** (You will hear intermittent beeper signal) and press the Down **button**.

You will see this symbol  on the display. The down position has been set.
Press & hold **SETUP button** for about 2 seconds until the **red SETUP led** is off.
The controller is now in normal operation mode.

Lift operating - control

D'Angle is delivered with a pre-programmed IR Remote. You can always re-program the preset buttons according to your will, as well as re-program any other remote



1. Programming a new IR remote.

The IR-Multicode system allows you to use any infrared remote control from most popular TV screen manufacturers using RC-5 Code. Every Sabaj controller can store 1 set of Infrared remote presets. This means that by programming new presets, you will delete the old ones. You can program the remote control with which you control your TV. Some newer remotes work on a Wi-Fi/Bluetooth bandwidth and, although they might look like a standard remote, they use a completely different wavelength. Please be advised, that **you will need the IR-EYE Sabaj Accessory connected to the controller via the RJ-45 socket to operate your lift with an IR remote**. To start acquiring the IR remote:

- a. Press & hold **SETUP button** for about 2 seconds – **red SETUP led** will be lit.
- b. Press **RC-SET (Memory) button** once – you will hear constant short beep signals. Then press **SETUP button** – beep signal will stop. You will see this symbol on the

display: . The control box is now awaiting IR signals.

- c. Aiming your remote towards the IR-Receiver, press **2 buttons** that you want to use for controlling the lift, one after another. Every properly received button signal will be confirmed by short pauses. Number of pauses correspond to the button set:

(I) - **UP** (1 beep) symbol . will appear on the display

(II) - **DOWN** (2 beeps) symbol . will appear on the display

- d. Press & hold **SETUP button** for about 2 seconds until the **red SETUP led** is off. The controller is now in normal operation mode.

To re-program new buttons, or assign new IR remote, repeat points a – d

NOTE: The programmed buttons of the remote control will be active at the same time for the device operated by this remote control. For example you can program the „OFF” button on your remote to hide the bracket and turn the TV off simultaneously. The lift can be operated by one remote control. The preferred ranges of motion will be the same for all remotes.

Setting favorite position

Movement accuracy: Please note that, due to many external reasons the accuracy of movement might be within the tolerance of 2° – 3°.

Using the programmed remote control, you can set the maximum range of motion and the favorite position.

To set the favorite position:

set the favorite position using **(I) and (II) buttons** – preferred position **should be set between the maximum position and complete closing of the mount**

Locking Mechanism: To engage or disengage the locking mechanism, the unit will always initiate a slight upward movement . This is normal behavior , which should be taken into account when operating.







Reset settings: To reset the settings for the motion ranges and favorite angles, press shortly the „B” button on the controller to enter the SETUP mode, and then press and hold the „A” button for about 3 seconds – you will hear 3 short beeps, the movement is now set to its defaults.



Sound messages: To turn off the sound signals, press and hold the button „A” on the control box for approx. 5 seconds. From now, the control box will not communicate its operations and programming – this can make it difficult to operate. To reactivate the „beeps”, cut the power and then turn it on again.

Active RJ-45 Socket: Your D’Angle series bracket is equipped with the active RJ-45 socket, which in standard version is used to connect an IR-EYE receiver. After connecting the RJ-SPLITTER, the socket allows you to connect additional accessories supplied by SABAJGROUP. The active RJ-45 socket enables you to use accessories for control through push-buttons, home automation systems, or smartphones. For more information, please visit the Sabaj website.

NOTE: Only the original SABAJGROUP accessories will work with your control box. If you attempt to modify or connect any other devices via the RJ-45 port, you might damage the control box and you will lose the warranty for doing so.

Drive/Tensioning belt – As long as the bracket withstands its natural movement, there is no risk of the belt wrapping around or being damaged. Any unnecessary movements, such as manually lifting and dropping the screen, or placing the screen disproportionately to the center axis of the bracket, might cause the belt to wrap, which can lead to failure. Operating an empty bracket is also not recommended , as some tension to the belt is necessary to operate properly . It is recommended to check if the belt is coiling up properly from time to time."

Digital Display messages		
Display	Explanation	Solution
	LIFT Limit switch cableharness disconnected	Check all the connections and contacts from Lift to control box. Some pins might be loose due to transportof furniture fitting
	Low VP Memory approved	-----
	LITF electric motor overload	Lower the LIFTs load
	LIFTs wiring disconnected	Check all the connections and contacts from LIFT wiring to control box. Some pins might be loose due to transport of furniture fitting.
	No impulses from LIFT's Motor	The LIFT motor might be blocked mechanically, unable to start moving. Cables might be loose. Many reasons to this error – please contact Sabaj support, providing photos of the installation
	Reset VP to factory defaults	-----
	Assign IR remote to control box	Press I and II consequently to program (only ECO-IR Version)

	UP button memory approved	-----
	DOWN button memory approved	-----